

# APPARATE ROLLEN

**Apparaterollen sind leicht und schlank gebaute Rollen mit Stahlblech- oder Kunststoffgehäuse, die vornehmlich im Innenbereich für leichte bis mittelschwere Geräte eingesetzt werden.**

Durch ihre Bauweise ermöglichen sie ein Maximum an Beweglichkeit der jeweiligen Geräte und bestechen durch hohe Laufruhe bei geringem Rollwiderstand.

Einsatzgebiete sind zum Beispiel Ladeneinrichtungen, Displays, Betriebseinrichtungen, Gerätebau, Medizintechnik und Pflegebereich.





50 - 100 KG

SERIE 21

- Durchmesser 50 - 150 mm
- Gehäuse aus Stahlblech
- Thermoplastisches Gummirad

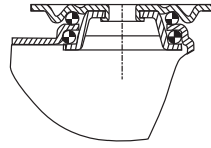

#### GEHÄUSE

- Stahlblech verzinkt-chromatiert
- Schwenklager mit zweifachem Kugelkranz
- Radachse verschraubt

#### RAD JPO

- Radkörper aus Polypropylen
- Lauffläche aus thermoplastischem Gummi
- Farbe grau, spurlos
- Gleitlager



#### LENKROLLE MIT ANSCHRAUBPLATTE

BESTELLCODE	mm	kg	mm	mm	mm	mm	mm	mm
<b>21L</b> JPO 050 P03	50	50	19	60 x 60	48,0 / 38,0 x 48,0 / 38,0	6,3	25	<b>70</b>
<b>21L</b> JPO 075 P03	75	75	25	60 x 60	48,0 / 38,0 x 48,0 / 38,0	6,3	24	<b>100</b>
<b>21L</b> JPO 100 P04	100	100	32	77 x 67	61,5 / 56,0 x 51,5 / 46,5	8,5	37	<b>135</b>
<b>21L</b> JPO 125 P04	125	100	32	77 x 67	61,5 / 56,0 x 51,5 / 46,5	8,5	40	<b>160</b>
<b>21L</b> JPO 125 P05	125	100	32	95 x 70	75,0 x 50,0	11,0	40	<b>160</b>
<b>21L</b> JPO 150 P04	150	100	32	77 x 67	61,5 / 56,0 x 51,5 / 46,5	8,5	44	<b>185</b>



#### LENKROLLE MIT ANSCHRAUBPLATTE UND TOTALFESTSTELLER

BESTELLCODE	mm	kg	mm	mm	mm	mm	mm	mm
<b>21N</b> JPO 050 P03	50	50	19	60 x 60	48,0 / 38,0 x 48,0 / 38,0	6,3	25	<b>70</b>
<b>21N</b> JPO 075 P03	75	75	25	60 x 60	48,0 / 38,0 x 48,0 / 38,0	6,3	24	<b>100</b>
<b>21N</b> JPO 100 P04	100	100	32	77 x 67	61,5 / 56,0 x 51,5 / 46,5	8,5	44	<b>135</b>
<b>21N</b> JPO 125 P04	125	100	32	77 x 67	61,5 / 56,0 x 51,5 / 46,5	8,5	42	<b>160</b>
<b>21N</b> JPO 125 P05	125	100	32	95 x 70	75,0 x 50,0	11,0	42	<b>160</b>
<b>21N</b> JPO 150 P04	150	100	32	77 x 67	61,5 / 56,0 x 51,5 / 46,5	8,5	41	<b>185</b>



#### LENKROLLE MIT ANSCHRAUBPLATTE UND RICHTUNGSFESTSTELLER

BESTELLCODE	mm	kg	mm	mm	mm	mm	mm	mm
<b>21I</b> JPO 100 P04	100	100	32	77 x 67	61,5 / 56,0 x 51,5 / 46,5	8,5	44	<b>135</b>
<b>21I</b> JPO 125 P04	125	100	32	77 x 67	61,5 / 56,0 x 51,5 / 46,5	8,5	42	<b>160</b>
<b>21I</b> JPO 150 P04	150	100	32	77 x 67	61,5 / 56,0 x 51,5 / 46,5	8,5	41	<b>185</b>



#### BOCKROLLE MIT ANSCHRAUBPLATTE

BESTELLCODE	mm	kg	mm	mm	mm	mm	mm	mm
<b>21B</b> JPO 050 P02	50	50	19	55 x 55	44,0 / 38,5 x 44,0 / 38,5	6,3		<b>70</b>
<b>21B</b> JPO 075 P14	75	75	25	67 x 60	48,0 / 40,0 x 48,0 / 40,0	6,3		<b>100</b>
<b>21B</b> JPO 100 P04	100	100	32	77 x 67	61,5 / 56,0 x 51,5 / 46,5	8,5		<b>135</b>
<b>21B</b> JPO 125 P04	125	100	32	77 x 67	61,5 / 56,0 x 51,5 / 46,5	8,5		<b>160</b>
<b>21B</b> JPO 125 P05	125	100	32	95 x 70	75,0 x 50,0	11,0		<b>160</b>
<b>21B</b> JPO 150 P04	150	100	32	77 x 67	61,5 / 56,0 x 51,5 / 46,5	8,5		<b>185</b>

## GEHÄUSE

- Stahlblech verzinkt-chromatiert
- Schwenklager mit zweifachem Kugelkranz
- Radachse verschraubt

## RAD JPO/JPI

- Radkörper aus Polypropylen
- Lauffläche aus thermoplastischem Gummi
- Farbe grau, spurlos
- Gleitlager
- JPI: Gleitlager zur Montage ohne Distanzrohr

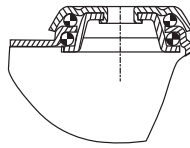

**50 - 100 KG**

- Durchmesser 50 - 150 mm
- Gehäuse aus Stahlblech
- Thermoplastisches Gummirad

**APPARATE  
ROLLEN**

SERIE **21**



## LENKROLLE MIT RÜCKENLOCH

BESTELLCODE	mm	kg	mm	mm	mm	mm
<b>21L JPO 050 P01</b>	<b>50</b>	<b>50</b>	19	11	25	<b>70</b>
<b>21L JPO 075 P01</b>	<b>75</b>	<b>75</b>	25	11	24	<b>100</b>
<b>21L JPO 100 P01</b>	<b>100</b>	<b>100</b>	32	11	37	<b>135</b>
<b>21L JPO 125 P01</b>	<b>125</b>	<b>100</b>	32	11	40	<b>160</b>
<b>21L JPO 150 P01</b>	<b>150</b>	<b>100</b>	32	11	44	<b>185</b>



## LENKROLLE MIT RÜCKENLOCH UND TOTALFESTSTELLER

BESTELLCODE	mm	kg	mm	mm	mm	mm
<b>21N JPO 050 P01</b>	<b>50</b>	<b>50</b>	19	11	25	<b>70</b>
<b>21N JPO 075 P01</b>	<b>75</b>	<b>75</b>	25	11	24	<b>100</b>
<b>21N JPO 100 P01</b>	<b>100</b>	<b>100</b>	32	11	44	<b>135</b>
<b>21N JPO 125 P01</b>	<b>125</b>	<b>100</b>	32	11	42	<b>160</b>
<b>21N JPO 150 P01</b>	<b>150</b>	<b>100</b>	32	11	41	<b>185</b>



## BOCKROLLE MIT RÜCKENLOCH

BESTELLCODE	mm	kg	mm	mm	mm
<b>21B JPO 075 P01</b>	<b>75</b>	<b>75</b>	25	11	<b>100</b>
<b>21B JPO 100 P01</b>	<b>100</b>	<b>100</b>	32	11	<b>135</b>
<b>21B JPO 125 P01</b>	<b>125</b>	<b>100</b>	32	11	<b>160</b>



## RAD

BESTELLCODE	mm	kg	mm	mm	mm
<b>JPI 050 x 19 - 6 - 22</b>	<b>50</b>	<b>50</b>	19	6	<b>22</b>
<b>JPO 050 x 19 - 8 - 22</b>	<b>50</b>	<b>50</b>	19	8	<b>22</b>
<b>JPI 075 x 25 - 6 - 27</b>	<b>75</b>	<b>75</b>	25	6	<b>27</b>
<b>JPO 075 x 25 - 8 - 27</b>	<b>75</b>	<b>75</b>	25	8	<b>27</b>
<b>JPO 100 x 32 - 12 - 35</b>	<b>100</b>	<b>100</b>	32	12	<b>35</b>
<b>JPO 125 x 32 - 12 - 35</b>	<b>125</b>	<b>100</b>	32	12	<b>35</b>
<b>JPO 150 x 32 - 12 - 35</b>	<b>150</b>	<b>100</b>	32	12	<b>35</b>



**VARIANTEN:** Auch mit Befestigungsschraube (S01) lieferbar.

Bei Rad-Ø 100 - 150 mm auch mit Rückenloch-Ø 13 mm lieferbar!



50 - 75 KG

- Durchmesser 50 - 75 mm
- Gehäuse aus Stahlblech
- Thermoplastisches Gummirad

SERIE 21

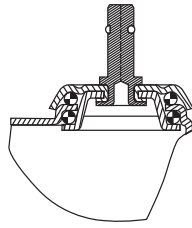

**GEHÄUSE**

- Stahlblech verzinkt-chromatiert
- Schwenklager mit zweifachem Kugelkranz
- Radachse verschraubt

**RAD JPO**

- Radkörper aus Polypropylen
- Lauffläche aus thermoplastischem Gummi
- Farbe grau, spurlos
- Gleitlager



**LENKROLLE MIT BUNDSTIFT**

BESTELLCODE	mm	kg	mm	mm	mm	mm
21L JPO 050 B11 - 11 x 31	50	50	19	11	25	73
21L JPO 075 B11 - 11 x 31	75	75	25	11	24	103



**LENKROLLE MIT BUNDSTIFT UND TOTALFESTSTELLER**

BESTELLCODE	mm	kg	mm	mm	mm	mm
21N JPO 050 B11 - 11 x 31	50	50	19	11	25	73
21N JPO 075 B11 - 11 x 31	75	75	25	11	24	103



**RAD**

BESTELLCODE	mm	kg	mm	mm	mm
JPO 050 x 19 - 8 - 22	50	50	19	8	22
JPO 075 x 25 - 8 - 27	75	75	25	8	27

**ROHREINSTECKHÜLSE 40KG**

VIERKANT [ 1 ]

BESTELLCODE	Hülsen- durchmesser in mm	Länge in mm
H01 - 16 x 16	16 x 16	36
H01 - 17 x 17	17 x 17	36
H01 - 18 x 18	18 x 18	36
H01 - 21 x 21	21 x 21	36
H01 - 22 x 22	22 x 22	36
H01 - 23 x 23	23 x 23	36
H01 - 26 x 26	26 x 26	36

RUND [ 2 ]

BESTELLCODE	Hülsen- durchmesser in mm	Länge in mm
H02 - 14	14	36
H02 - 15	15	36
H02 - 16	16	36
H02 - 17	17	36
H02 - 18	18	36
H02 - 19	19	36
H02 - 20	20	36
H02 - 22	22	36
H02 - 23	23	36

FÜR HOLZMÖBEL, RUND [ 3 ]

BESTELLCODE	Hülsen- durchmesser in mm	Länge in mm
H03 - 15	15	36

[ 1 ]                      [ 2 ]                      [ 3 ]



**VARIANTEN:** Auch mit Radtypen GYO (elektrisch leitfähig, spurlos) sowie mit JPP oder GYP (Präzisionskugellager) lieferbar

## GEHÄUSE

- Stahlblech verzinkt-chromatiert
- Schwenklager mit zweifachem Kugelkranz
- Radachse verschraubt

## RAD JPO

- Radkörper aus Polypropylen
- Lauffläche aus thermoplastischem Gummi
- Farbe grau, spurlos
- Gleitlager

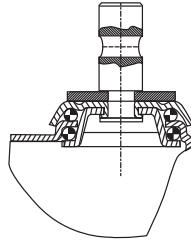

**50 - 100 KG**





- Durchmesser 50 - 150 mm
- Gehäuse aus Stahlblech
- Thermoplastisches Gummirad

**APPARATE  
ROLLEN**

SERIE **21**







### LENKROLLE MIT ZAPFENBEFESTIGUNG

BESTELLCODE	 mm	 kg	 mm	 mm	 mm
<b>21L</b> JPO 050 Z01	<b>50</b>	<b>50</b>	19	25	<b>73</b>
<b>21L</b> JPO 075 Z01	<b>75</b>	<b>75</b>	25	24	<b>103</b>
<b>21L</b> JPO 100 Z01	<b>100</b>	<b>100</b>	32	37	<b>138</b>
<b>21L</b> JPO 125 Z01	<b>125</b>	<b>100</b>	32	40	<b>163</b>
<b>21L</b> JPO 150 Z01	<b>150</b>	<b>100</b>	32	44	<b>188</b>







### LENKROLLE MIT ZAPFENBEFESTIGUNG UND TOTALFESTSTELLER

BESTELLCODE	 mm	 kg	 mm	 mm	 mm
<b>21N</b> JPO 050 Z01	<b>50</b>	<b>50</b>	19	25	<b>73</b>
<b>21N</b> JPO 075 Z01	<b>75</b>	<b>75</b>	25	24	<b>103</b>
<b>21N</b> JPO 100 Z01	<b>100</b>	<b>100</b>	32	44	<b>138</b>
<b>21N</b> JPO 125 Z01	<b>125</b>	<b>100</b>	32	42	<b>163</b>
<b>21N</b> JPO 150 Z01	<b>150</b>	<b>100</b>	32	41	<b>188</b>



### LENKROLLE MIT ZAPFENBEFESTIGUNG UND RICHTUNGSFESTSTELLER

BESTELLCODE	 mm	 kg	 mm	 mm	 mm
<b>21I</b> JPO 100 Z01	<b>100</b>	<b>100</b>	32	44	<b>138</b>
<b>21I</b> JPO 125 Z01	<b>125</b>	<b>100</b>	32	42	<b>163</b>
<b>21I</b> JPO 150 Z01	<b>150</b>	<b>100</b>	32	41	<b>188</b>

**HINWEIS:** bei Bestellung bitte immer **Zapfendurchmesser** angeben!

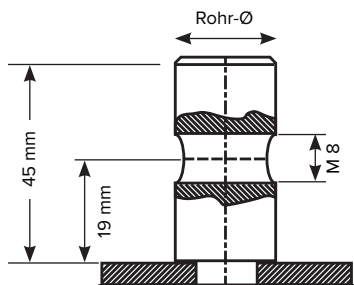

Befestigungszapfen Z01 lieferbar von 18 – 28 mm  
(Beschreibung siehe S. 25) sowie Sondermaße auf Anfrage.

Adapterhülse H04 (vierkant) und H05 (rund) ebenfalls erhältlich  
(Beschreibung siehe S. 25).



50 - 100 KG

- Durchmesser 50 - 150 mm
- Gehäuse aus Stahlblech
- Thermoplastisches Gummirad

SERIE 21

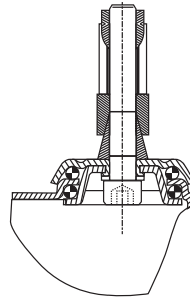

**GEHÄUSE**

- Stahlblech verzinkt-chromatiert
- Schwenklager mit zweifachem Kugelkranz
- Radachse verschraubt

**RAD JPO**

- Radkörper aus Polypropylen
- Lauffläche aus thermoplastischem Gummi
- Farbe grau, spurlos
- Gleitlager

**EXPANDERBEFESTIGUNG RUND**



BESTELLCODE	Rohr-Innen- durchmesser in mm	BESTELLCODE	Rohr-Innen- durchmesser in mm
Z06 - 18,0 - 20,0	18,0 - 20,0	Z06 - 24,0 - 27,0	24,0 - 27,0
Z06 - 19,0 - 21,5	19,0 - 21,5	Z06 - 27,0 - 30,0	27,0 - 30,0
Z06 - 21,5 - 24,0	21,5 - 24,0	Z06 - 31,0 - 35,0	31,0 - 35,0

**BITTE BEACHTEN:** Bei Bestellungen bitte immer das **Rohr-Innenmaß** angeben!



**LENKROLLE MIT EXPANDERBEFESTIGUNG RUND**

BESTELLCODE	mm	kg	mm	mm	mm
21L JPO 050 Z06	50	50	19	25	73
21L JPO 075 Z06	75	75	25	24	103
21L JPO 100 Z06	100	100	32	37	138
21L JPO 125 Z06	125	100	32	40	163
21L JPO 150 Z06	150	100	32	44	188



**LENKROLLE MIT EXPANDERBEFESTIGUNG RUND UND TOTALFESTSTELLER**

BESTELLCODE	mm	kg	mm	mm	mm
21N JPO 050 Z06	50	50	19	25	73
21N JPO 075 Z06	75	75	25	24	103
21N JPO 100 Z06	100	100	32	44	138
21N JPO 125 Z06	125	100	32	42	163
21N JPO 150 Z06	150	100	32	41	188

## GEHÄUSE

- Stahlblech verzinkt-chromatiert
- Schwenklager mit zweifachem Kugelkranz
- Radachse verschraubt

## RAD JPO

- Radkörper aus Polypropylen
- Lauffläche aus thermoplastischem Gummi
- Farbe grau, spurlos
- Gleitlager

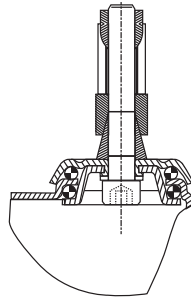

**50 - 100 KG**

- Durchmesser 50 - 150 mm
- Gehäuse aus Stahlblech
- Thermoplastisches Gummirad

**APPARATE  
ROLLEN**

SERIE **21**

## EXPANDERBEFESTIGUNG VIERKANT







BESTELLCODE	Rohr-Innen- durchmesser in mm
<b>Z07</b> - 18,0 - 20,0	<b>18,0 - 20,0</b>
<b>Z07</b> - 21,5 - 24,0	<b>21,5 - 24,0</b>
<b>Z07</b> - 24,0 - 27,0	<b>24,0 - 27,0</b>

BESTELLCODE	Rohr-Innen- durchmesser in mm
<b>Z07</b> - 27,0 - 30,0	<b>27,0 - 30,0</b>
<b>Z07</b> - 32,0 - 35,0	<b>32,0 - 35,0</b>
<b>Z07</b> - 36,0 - 40,0	<b>36,0 - 40,0</b>

**BITTE BEACHTEN:** Bei Bestellungen bitte immer das **Rohr-Innenmaß** angeben!





## LENKROLLE MIT EXPANDERBEFESTIGUNG VIERKANT



BESTELLCODE	 mm	 kg	 mm	 mm	 mm
<b>21L JPO 050 Z07</b>	<b>50</b>	<b>50</b>	19	25	<b>73</b>
<b>21L JPO 075 Z07</b>	<b>75</b>	<b>75</b>	25	24	<b>103</b>
<b>21L JPO 100 Z07</b>	<b>100</b>	<b>100</b>	32	37	<b>138</b>
<b>21L JPO 125 Z07</b>	<b>125</b>	<b>100</b>	32	40	<b>163</b>
<b>21L JPO 150 Z07</b>	<b>150</b>	<b>100</b>	32	44	<b>188</b>

## LENKROLLE MIT EXPANDERBEFESTIGUNG VIERKANT UND TOTALFESTSTELLER



BESTELLCODE	 mm	 kg	 mm	 mm	 mm
<b>21N JPO 050 Z07</b>	<b>50</b>	<b>50</b>	19	25	<b>73</b>
<b>21N JPO 075 Z07</b>	<b>75</b>	<b>75</b>	25	24	<b>103</b>
<b>21N JPO 100 Z07</b>	<b>100</b>	<b>100</b>	32	44	<b>138</b>
<b>21N JPO 125 Z07</b>	<b>125</b>	<b>100</b>	32	42	<b>163</b>
<b>21N JPO 150 Z07</b>	<b>150</b>	<b>100</b>	32	41	<b>188</b>



50 - 100 KG

SERIE **21**

- Durchmesser 50 - 150 mm
- Gehäuse aus Stahlblech
- Thermoplastisches Gummirad

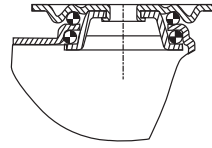

#### GEHÄUSE

- Stahlblech verzinkt-chromatiert
- Schwenklager mit zweifachem Kugelkranz
- Radachse verschraubt

#### RAD JPP

- Radkörper aus Polypropylen
- Lauffläche aus thermoplastischem Gummi
- Farbe grau, spurlos
- Fadenschutz
- Präzisionskugellager



#### LENKROLLE MIT ANSCHRAUBPLATTE

BESTELLCODE	mm	kg	mm	mm	mm	mm	mm	mm
<b>21L</b> JPP 050 P03	50	50	19	60 x 60	48,0 / 38,0 x 48,0 / 38,0	6,3	25	<b>70</b>
<b>21L</b> JPP 075 P03	75	75	25	60 x 60	48,0 / 38,0 x 48,0 / 38,0	6,3	24	<b>100</b>
<b>21L</b> JPP 100 P04	100	100	32	77 x 67	61,5 / 56,0 x 51,5 / 46,5	8,5	37	<b>135</b>
<b>21L</b> JPP 125 P04	125	100	32	77 x 67	61,5 / 56,0 x 51,5 / 46,5	8,5	40	<b>160</b>
<b>21L</b> JPP 125 P05	125	100	32	95 x 70	75,0 x 50,0	11,0	40	<b>160</b>
<b>21L</b> JPP 150 P04	150	100	32	77 x 67	61,5 / 56,0 x 51,5 / 46,5	8,5	44	<b>185</b>



#### LENKROLLE MIT ANSCHRAUBPLATTE UND TOTALFESTSTELLER

BESTELLCODE	mm	kg	mm	mm	mm	mm	mm	mm
<b>21N</b> JPP 050 P03	50	50	19	60 x 60	48,0 / 38,0 x 48,0 / 38,0	6,3	25	<b>70</b>
<b>21N</b> JPP 075 P03	75	75	25	60 x 60	48,0 / 38,0 x 48,0 / 38,0	6,3	24	<b>100</b>
<b>21N</b> JPP 100 P04	100	100	32	77 x 67	61,5 / 56,0 x 51,5 / 46,5	8,5	44	<b>135</b>
<b>21N</b> JPP 125 P04	125	100	32	77 x 67	61,5 / 56,0 x 51,5 / 46,5	8,5	42	<b>160</b>
<b>21N</b> JPP 125 P05	125	100	32	95 x 70	75,0 x 50,0	11,0	42	<b>160</b>
<b>21N</b> JPP 150 P04	150	100	32	77 x 67	61,5 / 56,0 x 51,5 / 46,5	8,5	41	<b>185</b>



#### LENKROLLE MIT ANSCHRAUBPLATTE UND RICHTUNGSFESTSTELLER

BESTELLCODE	mm	kg	mm	mm	mm	mm	mm	mm
<b>21I</b> JPP 100 P04	100	100	32	77 x 67	61,5 / 56,0 x 51,5 / 46,5	8,5	44	<b>135</b>
<b>21I</b> JPP 125 P04	125	100	32	77 x 67	61,5 / 56,0 x 51,5 / 46,5	8,5	42	<b>160</b>
<b>21I</b> JPP 150 P04	150	100	32	77 x 67	61,5 / 56,0 x 51,5 / 46,5	8,5	41	<b>185</b>



#### BOCKROLLE MIT ANSCHRAUBPLATTE

BESTELLCODE	mm	kg	mm	mm	mm	mm	mm	mm
<b>21B</b> JPP 050 P02	50	50	19	55 x 55	44,0 / 38,5 x 44,0 / 38,5	6,3		<b>70</b>
<b>21B</b> JPP 075 P14	75	75	25	67 x 60	48,0 / 40,0 x 48,0 / 40,0	6,3		<b>100</b>
<b>21B</b> JPP 100 P04	100	100	32	77 x 67	61,5 / 56,0 x 51,5 / 46,5	8,5		<b>135</b>
<b>21B</b> JPP 125 P04	125	100	32	77 x 67	61,5 / 56,0 x 51,5 / 46,5	8,5		<b>160</b>
<b>21B</b> JPP 125 P05	125	100	32	95 x 70	75,0 x 50,0	11,0		<b>160</b>
<b>21B</b> JPP 150 P04	150	100	32	77 x 67	61,5 / 56,0 x 51,5 / 46,5	8,5		<b>185</b>



**VARIANTEN:** Elektrisch leitfähige Version siehe S. 28



## GEHÄUSE

- Stahlblech verzinkt-chromatiert
- Schwenklager mit zweifachem Kugelkranz
- Radachse verschraubt

## RAD JPP

- Radkörper aus Polypropylen
- Lauffläche aus thermoplastischem Gummi
- Farbe grau, spurlos
- Fadenschutz
- Präzisionskugellager

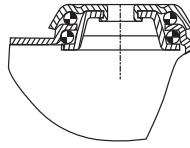

**50 - 100 KG**







- Durchmesser 50 - 150 mm
- Gehäuse aus Stahlblech
- Thermoplastisches Gummirad

**APPARATE  
ROLLEN**

SERIE **21**









### LENKROLLE MIT RÜCKENLOCH

BESTELLCODE	 mm	 kg	 mm	 mm	 mm	 mm
<b>21L JPP 050 P01</b>	<b>50</b>	<b>50</b>	19	11	25	<b>70</b>
<b>21L JPP 075 P01</b>	<b>75</b>	<b>75</b>	25	11	24	<b>100</b>
<b>21L JPP 100 P01</b>	<b>100</b>	<b>100</b>	32	11	37	<b>135</b>
<b>21L JPP 125 P01</b>	<b>125</b>	<b>100</b>	32	11	40	<b>160</b>
<b>21L JPP 150 P01</b>	<b>150</b>	<b>100</b>	32	11	44	<b>185</b>







### LENKROLLE MIT RÜCKENLOCH UND TOTALFESTSTELLER





BESTELLCODE	 mm	 kg	 mm	 mm	 mm	 mm
<b>21N JPP 050 P01</b>	<b>50</b>	<b>50</b>	19	11	25	<b>70</b>
<b>21N JPP 075 P01</b>	<b>75</b>	<b>75</b>	25	11	24	<b>100</b>
<b>21N JPP 100 P01</b>	<b>100</b>	<b>100</b>	32	11	44	<b>135</b>
<b>21N JPP 125 P01</b>	<b>125</b>	<b>100</b>	32	11	42	<b>160</b>
<b>21N JPP 150 P01</b>	<b>150</b>	<b>100</b>	32	11	41	<b>185</b>



### BOCKROLLE MIT RÜCKENLOCH

BESTELLCODE	 mm	 kg	 mm	 mm	 mm
<b>21B JPP 075 P01</b>	<b>75</b>	<b>75</b>	25	11	<b>100</b>
<b>21B JPP 100 P01</b>	<b>100</b>	<b>100</b>	32	11	<b>135</b>
<b>21B JPP 125 P01</b>	<b>125</b>	<b>100</b>	32	11	<b>160</b>

### RAD

BESTELLCODE	 mm	 kg	 mm	 mm	 mm
<b>JPP 050 x 19 - 6 - 22</b>	<b>50</b>	<b>50</b>	19	6	<b>22</b>
<b>JPP 075 x 25 - 6 - 28</b>	<b>75</b>	<b>75</b>	25	6	<b>28</b>
<b>JPP 100 x 32 - 8 - 36</b>	<b>100</b>	<b>100</b>	32	8	<b>36</b>
<b>JPP 125 x 32 - 8 - 36</b>	<b>125</b>	<b>100</b>	32	8	<b>36</b>
<b>JPP 150 x 32 - 8 - 36</b>	<b>150</b>	<b>100</b>	32	8	<b>36</b>
<b>JPP 200 x 32 - 8 - 36</b>	<b>200</b>	<b>100</b>	32	8	<b>36</b>



**VARIANTEN:** Auch mit Befestigungsschraube (S01) lieferbar.

Bei Rad-Ø 100 - 150 mm auch mit Rückenloch-Ø 13 mm lieferbar.



50 - 100 KG

SERIE 21

- Durchmesser 50 - 150 mm
- Gehäuse aus Stahlblech
- Thermoplastisches Gummirad

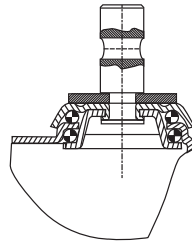

#### GEHÄUSE

- Stahlblech verzinkt-chromatiert
- Schwenklager mit zweifachem Kugelkranz
- Radachse verschraubt

#### RAD JPP

- Radkörper aus Polypropylen
- Lauffläche aus thermoplastischem Gummi
- Farbe grau, spurlos
- Fadenschutz
- Präzisionskugellager



#### LENKROLLE MIT ZAPFENBEFESTIGUNG

BESTELLCODE	mm	kg	mm	mm	mm
21L JPP 050 Z01	50	50	19	25	73
21L JPP 075 Z01	75	75	25	24	103
21L JPP 100 Z01	100	100	32	37	138
21L JPP 125 Z01	125	100	32	40	163
21L JPP 150 Z01	150	100	32	44	188



#### LENKROLLE MIT ZAPFENBEFESTIGUNG UND TOTALFESTSTELLER

BESTELLCODE	mm	kg	mm	mm	mm
21N JPP 050 Z01	50	50	19	25	73
21N JPP 075 Z01	75	75	25	24	103
21N JPP 100 Z01	100	100	32	44	138
21N JPP 125 Z01	125	100	32	42	163
21N JPP 150 Z01	150	100	32	41	188



#### LENKROLLE MIT ZAPFENBEFESTIGUNG UND RICHTUNGSFESTSTELLER

BESTELLCODE	mm	kg	mm	mm	mm
21I JPP 100 Z01	100	100	32	44	138
21I JPP 125 Z01	125	100	32	42	163
21I JPP 150 Z01	150	100	32	41	188

**HINWEIS:** bei Bestellung bitte immer **Zapfendurchmesser** angeben!

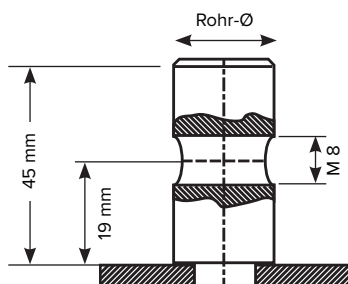

Befestigungszapfen Z01 lieferbar von 18 – 28 mm (Beschreibung siehe S.25)  
Sondermaße auf Anfrage.

Adapterhülse H04 (vierkant) und H05 (rund) ebenfalls erhältlich (Beschreibung siehe S. 25).

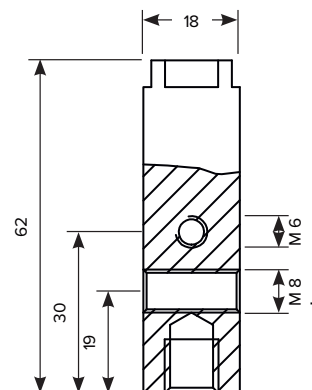

- Adapter-Reduzierhülsen für Rohrbefestigungen
- Befestigungszapfen

**ADAPTERHÜLSE** VIERKANT 

BESTELLCODE	für Rohr-Innen- durchmesser in mm	für Zapfenmaß (Ø) in mm
H04 - 22,5 - 18	22,5 x 22,5	18
H04 - 27,5 - 18	27,5 x 27,5	18
H04 - 27,0 - 22	27,0 x 27,0	22
H04 - 32,0 - 22	32,0 x 32,0	22
H04 - 36,0 - 22	36,0 x 36,0	22
H04 - 32,0 - 28	32,0 x 32,0	28
H04 - 33,6 - 28	33,6 x 33,6	28
H04 - 36,0 - 28	36,0 x 36,0	28

**ADAPTERHÜLSE** RUND 

BESTELLCODE	für Rohr-Innen- durchmesser in mm	für Zapfenmaß (Ø) in mm
H05 - 22,0 - 18	22,0	18
H05 - 22,5 - 18	22,5	18
H05 - 28,0 - 22	28,0	22
H05 - 30,0 - 18	30,0	18
H05 - 30,0 - 22	30,0	22

**BEFESTIGUNGSZAPFEN** RUND 

BESTELLCODE	für Rohr-Innen- durchmesser in mm	Zapfenlänge in mm
Z01 - 18 x 45	18	45
Z01 - 19 x 45	19	45
Z01 - 20 x 45	20	45
Z01 - 21 x 45	21	45
Z01 - 22 x 45	22	45
Z01 - 23 x 45	23	45
Z01 - 25 x 45	25	45
Z01 - 26 x 45	26	45
Z01 - 27 x 45	27	45
Z01 - 28 x 45	28	45
Z01 - 18 x 62 / M6 + M8	18	62





50 - 100 KG

- Durchmesser 50 - 150 mm
- Gehäuse aus Stahlblech
- Thermoplastisches Gummirad

SERIE 21

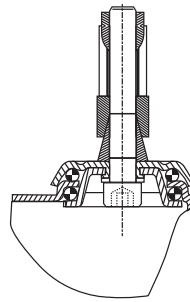

**GEHÄUSE**

- Stahlblech verzinkt-chromatiert
- Schwenklager mit zweifachem Kugelkranz
- Radachse verschraubt

**RAD JPP**

- Radkörper aus Polypropylen
- Lauffläche aus thermoplastischem Gummi
- Farbe grau, spurlos
- Fadenschutz
- Präzisionskugellager

**EXPANDERBEFESTIGUNG RUND**



BESTELLCODE	Rohr-Innen- durchmesser in mm	BESTELLCODE	Rohr-Innen- durchmesser in mm
Z06 - 18,0 - 20,0	<b>18,0 - 20,0</b>	Z06 - 24,0 - 27,0	<b>24,0 - 27,0</b>
Z06 - 19,0 - 21,5	<b>19,0 - 21,5</b>	Z06 - 27,0 - 30,0	<b>27,0 - 30,0</b>
Z06 - 21,5 - 24,0	<b>21,5 - 24,0</b>	Z06 - 31,0 - 35,0	<b>31,0 - 35,0</b>

**BITTE BEACHTEN:** Bei Bestellungen bitte immer das **Rohr-Innenmaß** angeben!



**LENKROLLE MIT EXPANDERBEFESTIGUNG RUND**

BESTELLCODE	mm	kg	mm	mm	mm
21L JPP 050 Z06	<b>50</b>	<b>50</b>	19	25	<b>73</b>
21L JPP 075 Z06	<b>75</b>	<b>75</b>	25	24	<b>103</b>
21L JPP 100 Z06	<b>100</b>	<b>100</b>	32	37	<b>138</b>
21L JPP 125 Z06	<b>125</b>	<b>100</b>	32	40	<b>163</b>
21L JPP 150 Z06	<b>150</b>	<b>100</b>	32	44	<b>188</b>



**LENKROLLE MIT EXPANDERBEFESTIGUNG RUND UND TOTALFESTSTELLER**

BESTELLCODE	mm	kg	mm	mm	mm
21N JPP 050 Z06	<b>50</b>	<b>50</b>	19	25	<b>73</b>
21N JPP 075 Z06	<b>75</b>	<b>75</b>	25	24	<b>103</b>
21N JPP 100 Z06	<b>100</b>	<b>100</b>	32	44	<b>138</b>
21N JPP 125 Z06	<b>125</b>	<b>100</b>	32	42	<b>163</b>
21N JPP 150 Z06	<b>150</b>	<b>100</b>	32	41	<b>188</b>

## GEHÄUSE

- Stahlblech verzinkt-chromatiert
- Schwenklager mit zweifachem Kugelkranz
- Radachse verschraubt

## RAD JPP

- Radkörper aus Polypropylen
- Lauffläche aus thermoplastischem Gummi
- Farbe grau, spurlos
- Fadenschutz
- Präzisionskugellager

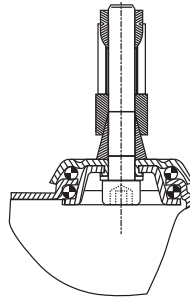

**50 - 100 KG**

- Durchmesser 50 - 150 mm
- Gehäuse aus Stahlblech
- Thermoplastisches Gummirad

**APPARATE  
ROLLEN**

SERIE **21**

## EXPANDERBEFESTIGUNG VIERKANT







BESTELLCODE	Rohr-Innen- durchmesser in mm
<b>Z07</b> - 18,0 - 20,0	<b>18,0 - 20,0</b>
<b>Z07</b> - 21,5 - 24,0	<b>21,5 - 24,0</b>
<b>Z07</b> - 24,0 - 27,0	<b>24,0 - 27,0</b>

BESTELLCODE	Rohr-Innen- durchmesser in mm
<b>Z07</b> - 27,0 - 30,0	<b>27,0 - 30,0</b>
<b>Z07</b> - 32,0 - 35,0	<b>32,0 - 35,0</b>
<b>Z07</b> - 36,0 - 40,0	<b>36,0 - 40,0</b>

**BITTE BEACHTEN:** Bei Bestellungen bitte immer das **Rohr-Innenmaß** angeben!





## LENKROLLE MIT EXPANDERBEFESTIGUNG VIERKANT



BESTELLCODE	 mm	 kg	 mm	 mm	 mm
<b>21L JPP 050 Z07</b>	<b>50</b>	<b>50</b>	19	25	<b>73</b>
<b>21L JPP 075 Z07</b>	<b>75</b>	<b>75</b>	25	24	<b>103</b>
<b>21L JPP 100 Z07</b>	<b>100</b>	<b>100</b>	32	37	<b>138</b>
<b>21L JPP 125 Z07</b>	<b>125</b>	<b>100</b>	32	40	<b>163</b>
<b>21L JPP 150 Z07</b>	<b>150</b>	<b>100</b>	32	44	<b>188</b>

## LENKROLLE MIT EXPANDERBEFESTIGUNG VIERKANT UND TOTALFESTSTELLER



BESTELLCODE	 mm	 kg	 mm	 mm	 mm
<b>21N JPP 050 Z07</b>	<b>50</b>	<b>50</b>	19	25	<b>73</b>
<b>21N JPP 075 Z07</b>	<b>75</b>	<b>75</b>	25	24	<b>103</b>
<b>21N JPP 100 Z07</b>	<b>100</b>	<b>100</b>	32	44	<b>138</b>
<b>21N JPP 125 Z07</b>	<b>125</b>	<b>100</b>	32	42	<b>163</b>
<b>21N JPP 150 Z07</b>	<b>150</b>	<b>100</b>	32	41	<b>188</b>



50 - 100 KG

SERIE 21



- Durchmesser 50 - 150 mm
- Gehäuse aus Stahlblech
- Thermoplastisches Gummirad
- elektrisch leitfähig

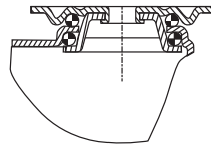

**GEHÄUSE**

- Stahlblech verzinkt-chromatiert
- Schwenklager mit zweifachem Kugelkranz
- Radachse verschraubt

**RAD GYP**

- Radkörper aus Polypropylen
- Lauffläche aus thermoplastischem Gummi, elektrisch leitfähig
- Farbe grau, spurlos
- Fadenschutz
- Präzisionskugellager



**LENKROLLE MIT ANSCHRAUBPLATTE**

BESTELLCODE	mm	kg	mm	mm	mm	mm	mm	mm
<b>21L</b> GYP 050 P03	50	50	19	60 x 60	48,0 / 38,0 x 48,0 / 38,0	6,3	25	<b>70</b>
<b>21L</b> GYP 075 P03	75	75	25	60 x 60	48,0 / 38,0 x 48,0 / 38,0	6,3	24	<b>100</b>
<b>21L</b> GYP 100 P04	100	100	32	77 x 67	61,5 / 56,0 x 51,5 / 46,5	8,5	37	<b>135</b>
<b>21L</b> GYP 125 P04	125	100	32	77 x 67	61,5 / 56,0 x 51,5 / 46,5	8,5	40	<b>160</b>
<b>21L</b> GYP 125 P05	125	100	32	95 x 70	75,0 x 50,0	11,0	40	<b>160</b>
<b>21L</b> GYP 150 P04	150	100	32	77 x 67	61,5 / 56,0 x 51,5 / 46,5	8,5	44	<b>185</b>



**LENKROLLE MIT ANSCHRAUBPLATTE UND TOTALFESTSTELLER**

BESTELLCODE	mm	kg	mm	mm	mm	mm	mm	mm
<b>21N</b> GYP 050 P03	50	50	19	60 x 60	48,0 / 38,0 x 48,0 / 38,0	6,3	25	<b>70</b>
<b>21N</b> GYP 075 P03	75	75	25	60 x 60	48,0 / 38,0 x 48,0 / 38,0	6,3	24	<b>100</b>
<b>21N</b> GYP 100 P04	100	100	32	77 x 67	61,5 / 56,0 x 51,5 / 46,5	8,5	44	<b>135</b>
<b>21N</b> GYP 125 P04	125	100	32	77 x 67	61,5 / 56,0 x 51,5 / 46,5	8,5	42	<b>160</b>
<b>21N</b> GYP 125 P05	125	100	32	95 x 70	75,0 x 50,0	11,0	42	<b>160</b>
<b>21N</b> GYP 150 P04	150	100	32	77 x 67	61,5 / 56,0 x 51,5 / 46,5	8,5	41	<b>185</b>



**LENKROLLE MIT ANSCHRAUBPLATTE UND RICHTUNGSFESTSTELLER**

BESTELLCODE	mm	kg	mm	mm	mm	mm	mm	mm
<b>21I</b> GYP 100 P04	100	100	32	77 x 67	61,5 / 56,0 x 51,5 / 46,5	8,5	44	<b>135</b>
<b>21I</b> GYP 125 P04	125	100	32	77 x 67	61,5 / 56,0 x 51,5 / 46,5	8,5	42	<b>160</b>
<b>21I</b> GYP 150 P04	150	100	32	77 x 67	61,5 / 56,0 x 51,5 / 46,5	8,5	41	<b>185</b>



**BOCKROLLE MIT ANSCHRAUBPLATTE**

BESTELLCODE	mm	kg	mm	mm	mm	mm	mm	mm
<b>21B</b> GYP 050 P02	50	50	19	55 x 55	44,0 / 38,5 x 44,0 / 38,5	6,3		<b>70</b>
<b>21B</b> GYP 075 P14	75	75	25	67 x 60	48,0 / 40,0 x 48,0 / 40,0	6,3		<b>100</b>
<b>21B</b> GYP 100 P04	100	100	32	77 x 67	61,5 / 56,0 x 51,5 / 46,5	8,5		<b>135</b>
<b>21B</b> GYP 125 P04	125	100	32	77 x 67	61,5 / 56,0 x 51,5 / 46,5	8,5		<b>160</b>
<b>21B</b> GYP 125 P05	125	100	32	95 x 70	75,0 x 50,0	11,0		<b>160</b>
<b>21B</b> GYP 150 P04	150	100	32	77 x 67	61,5 / 56,0 x 51,5 / 46,5	8,5		<b>185</b>



**VARIANTEN:** Auch mit Gleitlager GYO (elektrisch leitfähig, spurlos) lieferbar.

Bitte beachten Sie auch unsere Sicherheitshinweise zur Leitfähigkeit auf Seite 10.

## GEHÄUSE

- Stahlblech verzinkt-chromatiert
- Schwenklager mit zweifachem Kugelkranz
- Radachse verschraubt

## RAD GYP

- Radkörper aus Polypropylen
- Lauffläche aus thermoplastischem Gummi, elektrisch leitfähig
- Farbe grau, spurlos
- Fadenschutz
- Präzisionskugellager

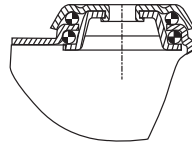

**50 - 100 KG**

- Durchmesser 50 - 150 mm
- Gehäuse aus Stahlblech
- Thermoplastisches Gummirad
- elektrisch leitfähig

**APPARATE  
ROLLEN**

SERIE **21**



## LENKROLLE MIT RÜCKENLOCH

BESTELLCODE	mm	kg	mm	mm	mm	mm
<b>21L</b> GYP 050 P01	<b>50</b>	<b>50</b>	19	11	25	<b>70</b>
<b>21L</b> GYP 075 P01	<b>75</b>	<b>75</b>	25	11	24	<b>100</b>
<b>21L</b> GYP 100 P01	<b>100</b>	<b>100</b>	32	11	37	<b>135</b>
<b>21L</b> GYP 125 P01	<b>125</b>	<b>100</b>	32	11	40	<b>160</b>
<b>21L</b> GYP 150 P01	<b>150</b>	<b>100</b>	32	11	44	<b>185</b>



## LENKROLLE MIT RÜCKENLOCH UND TOTALFESTSTELLER

BESTELLCODE	mm	kg	mm	mm	mm	mm
<b>21N</b> GYP 050 P01	<b>50</b>	<b>50</b>	19	11	25	<b>70</b>
<b>21N</b> GYP 075 P01	<b>75</b>	<b>75</b>	25	11	24	<b>100</b>
<b>21N</b> GYP 100 P01	<b>100</b>	<b>100</b>	32	11	44	<b>135</b>
<b>21N</b> GYP 125 P01	<b>125</b>	<b>100</b>	32	11	42	<b>160</b>
<b>21N</b> GYP 150 P01	<b>150</b>	<b>100</b>	32	11	41	<b>185</b>



## BOCKROLLE MIT RÜCKENLOCH

BESTELLCODE	mm	kg	mm	mm	mm
<b>21B</b> GYP 075 P01	<b>75</b>	<b>75</b>	25	11	<b>100</b>
<b>21B</b> GYP 100 P01	<b>100</b>	<b>100</b>	32	11	<b>135</b>
<b>21B</b> GYP 125 P01	<b>125</b>	<b>100</b>	32	11	<b>160</b>

## RAD

BESTELLCODE	mm	kg	mm	mm	mm
<b>GYP</b> 050 x 19 - 6 - <b>22</b>	<b>50</b>	<b>50</b>	19	6	<b>22</b>
<b>GYP</b> 075 x 25 - 6 - <b>28</b>	<b>75</b>	<b>75</b>	25	6	<b>28</b>
<b>GYP</b> 100 x 32 - 8 - <b>36</b>	<b>100</b>	<b>100</b>	32	8	<b>36</b>
<b>GYP</b> 125 x 32 - 8 - <b>36</b>	<b>125</b>	<b>100</b>	32	8	<b>36</b>
<b>GYP</b> 150 x 32 - 8 - <b>36</b>	<b>150</b>	<b>100</b>	32	8	<b>36</b>
<b>GYP</b> 200 x 32 - 8 - <b>36</b>	<b>200</b>	<b>100</b>	32	8	<b>36</b>

**VARIANTEN:** Auch mit Befestigungsschraube (S01) lieferbar.

Bei Rad-Ø 100 - 150 mm auch mit Rückenloch-Ø 13 mm lieferbar.

Bitte beachten Sie auch unsere Sicherheitshinweise zur Leitfähigkeit auf Seite 10.



50 - 100 KG

- Durchmesser 50 - 150 mm
- Gehäuse aus Stahlblech
- Thermoplastisches Gummirad
- elektrisch leitfähig

SERIE 21

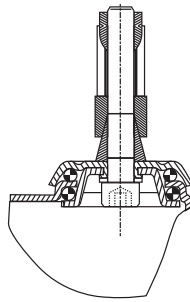

**GEHÄUSE**

- Stahlblech verzinkt-chromatiert
- Schwenklager mit zweifachem Kugelkranz
- Radachse verschraubt

**RAD GYP**

- Radkörper aus Polypropylen
- Lauffläche aus thermoplastischem Gummi, elektrisch leitfähig
- Farbe grau, spurlos
- Fadenschutz
- Präzisionskugellager

**EXPANDERBEFESTIGUNG RUND**



BESTELLCODE	Rohr-Innen- durchmesser in mm
Z06 - 18,0 - 20,0	18,0 - 20,0
Z06 - 19,0 - 21,5	19,0 - 21,5
Z06 - 21,5 - 24,0	21,5 - 24,0

BESTELLCODE	Rohr-Innen- durchmesser in mm
Z06 - 24,0 - 27,0	24,0 - 27,0
Z06 - 27,0 - 30,0	27,0 - 30,0
Z06 - 31,0 - 35,0	31,0 - 35,0

**BITTE BEACHTEN:** Bei Bestellungen bitte immer das **Rohr-Innenmaß** angeben!

**LENKROLLE MIT EXPANDERBEFESTIGUNG RUND**



BESTELLCODE	mm	kg	mm	mm	mm
21L GYP 050 Z06	50	50	19	25	73
21L GYP 075 Z06	75	75	25	24	103
21L GYP 100 Z06	100	100	32	37	138
21L GYP 125 Z06	125	100	32	40	163
21L GYP 150 Z06	150	100	32	44	188

**LENKROLLE MIT EXPANDERBEFESTIGUNG RUND UND TOTALFESTSTELLER**



BESTELLCODE	mm	kg	mm	mm	mm
21N GYP 050 Z06	50	50	19	25	73
21N GYP 075 Z06	75	75	25	24	103
21N GYP 100 Z06	100	100	32	44	138
21N GYP 125 Z06	125	100	32	42	163
21N GYP 150 Z06	150	100	32	41	188

Bitte beachten Sie auch unsere Sicherheitshinweise zur Leitfähigkeit auf Seite 10.



## GEHÄUSE

- Stahlblech verzinkt-chromatiert
- Schwenklager mit zweifachem Kugelkranz
- Radachse verschraubt

## RAD GYP

- Radkörper aus Polypropylen
- Lauffläche aus thermoplastischem Gummi, elektrisch leitfähig
- Farbe grau, spurlos
- Fadenschutz
- Präzisionskugellager

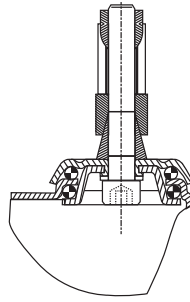

**50 - 100 KG**

- Durchmesser 50 - 150 mm
- Gehäuse aus Stahlblech
- Thermoplastisches Gummirad
- elektrisch leitfähig

**APPARATE  
ROLLEN**

SERIE **21**



## EXPANDERBEFESTIGUNG VIERKANT







BESTELLCODE	Rohr-Innen- durchmesser in mm
<b>Z07</b> - 18,0 - 20,0	<b>18,0 - 20,0</b>
<b>Z07</b> - 21,5 - 24,0	<b>21,5 - 24,0</b>
<b>Z07</b> - 24,0 - 27,0	<b>24,0 - 27,0</b>

BESTELLCODE	Rohr-Innen- durchmesser in mm
<b>Z07</b> - 27,0 - 30,0	<b>27,0 - 30,0</b>
<b>Z07</b> - 32,0 - 35,0	<b>32,0 - 35,0</b>
<b>Z07</b> - 36,0 - 40,0	<b>36,0 - 40,0</b>

**BITTE BEACHTEN:** Bei Bestellungen bitte immer das **Rohr-Innenmaß** angeben!





## LENKROLLE MIT EXPANDERBEFESTIGUNG VIERKANT



BESTELLCODE	 mm	 kg	 mm	 mm	 mm
<b>21L GYP 050 Z07</b>	<b>50</b>	<b>50</b>	19	25	<b>73</b>
<b>21L GYP 075 Z07</b>	<b>75</b>	<b>75</b>	25	24	<b>103</b>
<b>21L GYP 100 Z07</b>	<b>100</b>	<b>100</b>	32	37	<b>138</b>
<b>21L GYP 125 Z07</b>	<b>125</b>	<b>100</b>	32	40	<b>163</b>
<b>21L GYP 150 Z07</b>	<b>150</b>	<b>100</b>	32	44	<b>188</b>

## LENKROLLE MIT EXPANDERBEFESTIGUNG VIERKANT UND TOTALFESTSTELLER



BESTELLCODE	 mm	 kg	 mm	 mm	 mm
<b>21N GYP 050 Z07</b>	<b>50</b>	<b>50</b>	19	25	<b>73</b>
<b>21N GYP 075 Z07</b>	<b>75</b>	<b>75</b>	25	24	<b>103</b>
<b>21N GYP 100 Z07</b>	<b>100</b>	<b>100</b>	32	44	<b>138</b>
<b>21N GYP 125 Z07</b>	<b>125</b>	<b>100</b>	32	42	<b>163</b>
<b>21N GYP 150 Z07</b>	<b>150</b>	<b>100</b>	32	41	<b>188</b>

Bitte beachten Sie auch unsere Sicherheitshinweise zur Leitfähigkeit auf Seite 10.



50 - 100 KG

- Durchmesser 50 - 150 mm
- Gehäuse aus Stahlblech
- Polyurethanrad

SERIE 21

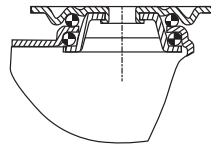

**GEHÄUSE**

- Stahlblech verzinkt-chromatiert
- Schwenklager mit zweifachem Kugelkranz
- Radachse verschraubt

**RAD AUP**

- Radkörper aus Polyamid
- Lauffläche aus Polyurethan
- Fadenschutz
- Präzisionskugellager



**LENKROLLE MIT ANSCHRAUBPLATTE**

BESTELLCODE	mm	kg	mm	mm	mm	mm	mm	mm
<b>21L</b> AUP 050 P03	50	50	19	60 x 60	48,0 / 38,0 x 48,0 / 38,0	6,3	25	<b>70</b>
<b>21L</b> AUP 075 P03	75	75	25	60 x 60	48,0 / 38,0 x 48,0 / 38,0	6,3	24	<b>100</b>
<b>21L</b> AUP 100 P04	100	100	32	77 x 67	61,5 / 56,0 x 51,5 / 46,5	8,5	37	<b>135</b>
<b>21L</b> AUP 125 P04	125	100	32	77 x 67	61,5 / 56,0 x 51,5 / 46,5	8,5	40	<b>160</b>
<b>21L</b> AUP 125 P05	125	100	32	95 x 70	75,0 x 50,0	11,0	40	<b>160</b>
<b>21L</b> AUP 150 P04	150	100	32	77 x 67	61,5 / 56,0 x 51,5 / 46,5	8,5	44	<b>185</b>



**LENKROLLE MIT ANSCHRAUBPLATTE UND TOTALFESTSTELLER**

BESTELLCODE	mm	kg	mm	mm	mm	mm	mm	mm
<b>21N</b> AUP 050 P03	50	50	19	60 x 60	48,0 / 38,0 x 48,0 / 38,0	6,3	25	<b>70</b>
<b>21N</b> AUP 075 P03	75	75	25	60 x 60	48,0 / 38,0 x 48,0 / 38,0	6,3	24	<b>100</b>
<b>21N</b> AUP 100 P04	100	100	32	77 x 67	61,5 / 56,0 x 51,5 / 46,5	8,5	44	<b>135</b>
<b>21N</b> AUP 125 P04	125	100	32	77 x 67	61,5 / 56,0 x 51,5 / 46,5	8,5	42	<b>160</b>
<b>21N</b> AUP 125 P05	125	100	32	95 x 70	75,0 x 50,0	11,0	42	<b>160</b>
<b>21N</b> AUP 150 P04	150	100	32	77 x 67	61,5 / 56,0 x 51,5 / 46,5	8,5	41	<b>185</b>



**LENKROLLE MIT ANSCHRAUBPLATTE UND RICHTUNGSFESTSTELLER**

BESTELLCODE	mm	kg	mm	mm	mm	mm	mm	mm
<b>21I</b> AUP 100 P04	100	100	32	77 x 67	61,5 / 56,0 x 51,5 / 46,5	8,5	44	<b>135</b>
<b>21I</b> AUP 125 P04	125	100	32	77 x 67	61,5 / 56,0 x 51,5 / 46,5	8,5	42	<b>160</b>
<b>21I</b> AUP 150 P04	150	100	32	77 x 67	61,5 / 56,0 x 51,5 / 46,5	8,5	41	<b>185</b>



**BOCKROLLE MIT ANSCHRAUBPLATTE**

BESTELLCODE	mm	kg	mm	mm	mm	mm	mm	mm
<b>21B</b> AUP 050 P02	50	50	19	55 x 55	44,0 / 38,5 x 44,0 / 38,5	6,3		<b>70</b>
<b>21B</b> AUP 075 P14	75	75	25	67 x 60	48,0 / 40,0 x 48,0 / 40,0	6,3		<b>100</b>
<b>21B</b> AUP 100 P04	100	100	32	77 x 67	61,5 / 56,0 x 51,5 / 46,5	8,5		<b>135</b>
<b>21B</b> AUP 125 P04	125	100	32	77 x 67	61,5 / 56,0 x 51,5 / 46,5	8,5		<b>160</b>
<b>21B</b> AUP 125 P05	125	100	32	95 x 70	75,0 x 50,0	11,0		<b>160</b>
<b>21B</b> AUP 150 P04	150	100	32	77 x 67	61,5 / 56,0 x 51,5 / 46,5	8,5		<b>185</b>

## GEHÄUSE

- Stahlblech verzinkt-chromatiert
- Schwenklager mit zweifachem Kugelkranz
- Radachse verschraubt

## RAD AUP

- Radkörper aus Polyamid
- Lauffläche aus Polyurethan
- Fadenschutz
- Präzisionskugellager

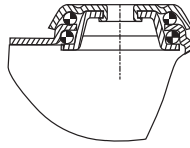

**50 - 100 KG**







- Durchmesser 50 - 150 mm
- Gehäuse aus Stahlblech
- Polyurethanrad

**APPARATE  
ROLLEN**

SERIE **21**









## LENKROLLE MIT RÜCKENLOCH





BESTELLCODE	 mm	 kg	 mm	 mm	 mm	 mm
<b>21L AUP 050 P01</b>	<b>50</b>	<b>50</b>	19	11	25	<b>70</b>
<b>21L AUP 075 P01</b>	<b>75</b>	<b>75</b>	25	11	24	<b>100</b>
<b>21L AUP 100 P01</b>	<b>100</b>	<b>100</b>	32	11	37	<b>135</b>
<b>21L AUP 125 P01</b>	<b>125</b>	<b>100</b>	32	11	40	<b>160</b>
<b>21L AUP 150 P01</b>	<b>150</b>	<b>100</b>	32	11	44	<b>185</b>



## LENKROLLE MIT RÜCKENLOCH UND TOTALFESTSTELLER

BESTELLCODE	 mm	 kg	 mm	 mm	 mm	 mm
<b>21N AUP 050 P01</b>	<b>50</b>	<b>50</b>	19	11	25	<b>70</b>
<b>21N AUP 075 P01</b>	<b>75</b>	<b>75</b>	25	11	24	<b>100</b>
<b>21N AUP 100 P01</b>	<b>100</b>	<b>100</b>	32	11	44	<b>135</b>
<b>21N AUP 125 P01</b>	<b>125</b>	<b>100</b>	32	11	42	<b>160</b>
<b>21N AUP 150 P01</b>	<b>150</b>	<b>100</b>	32	11	41	<b>185</b>

## RAD

BESTELLCODE	 mm	 kg	 mm	 mm	 mm
<b>AUP 050 x 19 - 6 - 22</b>	<b>50</b>	<b>50</b>	19	6	<b>22</b>
<b>AUP 075 x 25 - 6 - 28</b>	<b>75</b>	<b>75</b>	25	6	<b>28</b>
<b>AUP 100 x 32 - 8 - 36</b>	<b>100</b>	<b>150</b>	32	8	<b>36</b>
<b>AUP 125 x 32 - 8 - 36</b>	<b>125</b>	<b>150</b>	32	8	<b>36</b>
<b>AUP 150 x 32 - 8 - 36</b>	<b>150</b>	<b>150</b>	32	8	<b>36</b>



 **VARIANTEN:** Teilweise auch mit Rad SXP (elektrisch leitfähig, spurlos) lieferbar.



50 - 100 KG

- Durchmesser 50 - 125 mm
- Gehäuse aus Stahlblech
- Polyamidrad - Polypropylenrad

SERIE **21**

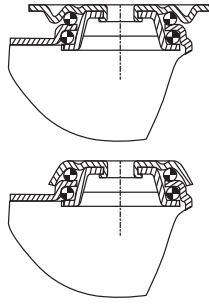

**GEHÄUSE**

- Stahlblech verzinkt-chromatiert
- Schwenklager mit zweifachem Kugelkranz
- Radachse verschraubt

**RAD OUO**

- Rad aus Polyamid
- Gleitlager

**RAD OPO**

- Rad aus Polypropylen
- Gleitlager



**LENKROLLE MIT ANSCHRAUBPLATTE**

BESTELLCODE	mm	kg	mm	mm	mm	mm	mm
<b>21L</b> OUO 050 P03	50	50	19	60 x 60	48,0 / 38,0 x 48,0 / 38,0	6,3	25 <b>70</b>
<b>21L</b> OUO 075 P03	75	75	23	60 x 60	48,0 / 38,0 x 48,0 / 38,0	6,3	24 <b>100</b>
<b>21L</b> OPO 100 P04	100	80	32	77 x 67	61,5 / 56,0 x 51,5 / 46,5	8,5	37 <b>135</b>
<b>21L</b> OPO 125 P04	125	100	32	77 x 67	61,5 / 56,0 x 51,5 / 46,5	8,5	40 <b>160</b>



**LENKROLLE MIT ANSCHRAUBPLATTE UND TOTALFESTSTELLER**

BESTELLCODE	mm	kg	mm	mm	mm	mm	mm
<b>21N</b> OUO 050 P03	50	50	19	60 x 60	48,0 / 38,0 x 48,0 / 38,0	6,3	25 <b>70</b>
<b>21N</b> OUO 075 P03	75	75	23	60 x 60	48,0 / 38,0 x 48,0 / 38,0	6,3	24 <b>100</b>
<b>21N</b> OPO 100 P04	100	80	32	77 x 67	61,5 / 56,0 x 51,5 / 46,5	8,5	44 <b>135</b>
<b>21N</b> OPO 125 P04	125	100	32	77 x 67	61,5 / 56,0 x 51,5 / 46,5	8,5	42 <b>160</b>



**LENKROLLE MIT RÜCKENLOCH**

BESTELLCODE	mm	kg	mm	mm	mm	mm
<b>21L</b> OUO 050 P01	50	50	19	11	25	<b>70</b>
<b>21L</b> OUO 075 P01	75	75	23	11	24	<b>100</b>
<b>21L</b> OPO 100 P01	100	80	32	11	37	<b>135</b>
<b>21L</b> OPO 125 P01	125	100	32	11	40	<b>160</b>



**LENKROLLE MIT RÜCKENLOCH UND TOTALFESTSTELLER**

BESTELLCODE	mm	kg	mm	mm	mm	mm
<b>21N</b> OUO 050 P01	50	50	19	11	25	<b>70</b>
<b>21N</b> OUO 075 P01	75	75	23	11	24	<b>100</b>
<b>21N</b> OPO 100 P01	100	80	32	11	44	<b>135</b>
<b>21N</b> OPO 125 P01	125	100	32	11	42	<b>160</b>

## GEHÄUSE

- Stahlblech verzinkt-chromatiert
- Schwenklager mit zweifachem Kugelkranz
- Radachse verschraubt

## RAD ODO

- Rad aus Polyamid
- Gleitlager

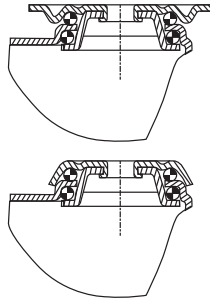

**70 - 100 KG**









- Durchmesser 50 - 75 mm
- Gehäuse aus Stahlblech
- Polyamidrad

**APPARATE  
ROLLEN**

SERIE **24**











### DOPPEL-LENKROLLE MIT ANSCHRAUBPLATTE

BESTELLCODE	 mm	 kg	 mm	 mm	 mm	 mm	 mm	 mm
<b>24L</b> ODO 050 P03	50	70	2 x 19	60 x 60	48,0 / 38,0 x 48,0 / 38,0	6,3	25	73
<b>24L</b> ODO 075 P04	75	100	2 x 23	77 x 67	61,5 / 56,0 x 51,5 / 46,5	8,5	32	102









### DOPPEL-LENKROLLE MIT ANSCHRAUBPLATTE UND TOTALFESTSTELLER

BESTELLCODE	 mm	 kg	 mm	 mm	 mm	 mm	 mm	 mm
<b>24N</b> ODO 050 P03	50	70	2 x 19	60 x 60	48,0 / 38,0 x 48,0 / 38,0	6,3	25	73
<b>24N</b> ODO 075 P04	75	100	2 x 23	77 x 67	61,5 / 56,0 x 51,5 / 46,5	8,5	32	102







### DOPPEL-LENKROLLE MIT RÜCKENLOCH

BESTELLCODE	 mm	 kg	 mm	 mm	 mm	 mm
<b>24L</b> ODO 050 P01	50	70	2 x 19	11	25	70
<b>24L</b> ODO 075 P01	75	100	2 x 23	11	32	99



### DOPPEL-LENKROLLE MIT RÜCKENLOCH UND TOTALFESTSTELLER

BESTELLCODE	 mm	 kg	 mm	 mm	 mm	 mm
<b>24N</b> ODO 050 P01	50	70	2 x 19	11	25	70
<b>24N</b> ODO 075 P01	75	100	2 x 23	11	32	99



70 - 100 KG

- Durchmesser 50 - 75 mm
- Gehäuse aus Stahlblech
- Thermoplastisches Gummirad

SERIE **24**

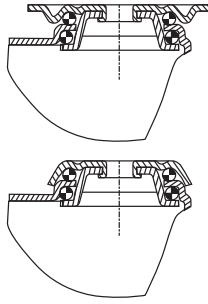

**GEHÄUSE**

- Stahlblech verzinkt-chromatiert
- Schwenklager mit zweifachem Kugelkranz
- Radachse verschraubt

**RAD JPO**

- Radkörper aus Polypropylen
- Lauffläche aus thermo-  
plastischem Gummi
- Farbe grau, spurlos
- Gleitlager



**DOPPEL-LENKROLLE MIT ANSCHRAUBPLATTE**

BESTELLCODE	mm	kg	mm	mm	mm	mm	mm	mm
<b>24L</b> JPO 050 P03	50	70	2 x 19	60 x 60	48,0 / 38,0 x 48,0 / 38,0	6,3	25	<b>73</b>
<b>24L</b> JPO 075 P04	75	100	2 x 25	77 x 67	61,5 / 56,0 x 51,5 / 46,5	8,5	32	<b>102</b>



**DOPPEL-LENKROLLE MIT ANSCHRAUBPLATTE UND TOTALFESTSTELLER**

BESTELLCODE	mm	kg	mm	mm	mm	mm	mm	mm
<b>24N</b> JPO 050 P03	50	70	2 x 19	60 x 60	48,0 / 38,0 x 48,0 / 38,0	6,3	25	<b>73</b>
<b>24N</b> JPO 075 P04	75	100	2 x 25	77 x 67	61,5 / 56,0 x 51,5 / 46,5	8,5	32	<b>102</b>



**DOPPEL-LENKROLLE MIT RÜCKENLOCH**

BESTELLCODE	mm	kg	mm	mm	mm	mm
<b>24L</b> JPO 050 P01	50	70	2 x 19	11	25	<b>70</b>
<b>24L</b> JPO 075 P01	75	100	2 x 25	11	32	<b>99</b>



**DOPPEL-LENKROLLE MIT RÜCKENLOCH UND TOTALFESTSTELLER**

BESTELLCODE	mm	kg	mm	mm	mm	mm
<b>24N</b> JPO 050 P01	50	70	2 x 19	11	25	<b>70</b>
<b>24N</b> JPO 075 P01	75	100	2 x 25	11	32	<b>99</b>

## GEHÄUSE

- Stahlblech verzinkt-chromatiert
- Schwenklager mit zweifachem Kugelkranz
- Radachse verschraubt

## RAD JPP

- Radkörper aus Polypropylen
- Lauffläche aus thermo-plastischem Gummi
- Farbe grau, spurlos
- Fadenschutz
- Präzisionskugellager

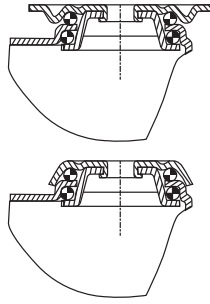

**70 - 100 KG**









- Durchmesser 50 - 75 mm
- Gehäuse aus Stahlblech
- Thermoplastisches Gummirad

**APPARATE  
ROLLEN**

SERIE **24**











### DOPPEL-LENKROLLE MIT ANSCHRAUBPLATTE

BESTELLCODE	 mm	 kg	 mm	 mm	 mm	 mm	 mm	 mm
<b>24L</b> JPP 050 P03	<b>50</b>	<b>70</b>	2 x 19	60 x 60	48,0 / 38,0 x 48,0 / 38,0	6,3	25	<b>73</b>
<b>24L</b> JPP 075 P04	<b>75</b>	<b>100</b>	2 x 25	77 x 67	61,5 / 56,0 x 51,5 / 46,5	8,5	32	<b>102</b>







### DOPPEL-LENKROLLE MIT ANSCHRAUBPLATTE UND TOTALFESTSTELLER

BESTELLCODE	 mm	 kg	 mm	 mm	 mm	 mm	 mm	 mm
<b>24N</b> JPP 050 P03	<b>50</b>	<b>70</b>	2 x 19	60 x 60	48,0 / 38,0 x 48,0 / 38,0	6,3	25	<b>73</b>
<b>24N</b> JPP 075 P04	<b>75</b>	<b>100</b>	2 x 25	77 x 67	61,5 / 56,0 x 51,5 / 46,5	8,5	32	<b>102</b>







### DOPPEL-LENKROLLE MIT RÜCKENLOCH

BESTELLCODE	 mm	 kg	 mm	 mm	 mm	 mm
<b>24L</b> JPP 050 P01	<b>50</b>	<b>70</b>	2 x 19	11	25	<b>70</b>
<b>24L</b> JPP 075 P01	<b>75</b>	<b>100</b>	2 x 25	11	32	<b>99</b>



### DOPPEL-LENKROLLE MIT RÜCKENLOCH UND TOTALFESTSTELLER

BESTELLCODE	 mm	 kg	 mm	 mm	 mm	 mm
<b>24N</b> JPP 050 P01	<b>50</b>	<b>70</b>	2 x 19	11	25	<b>70</b>
<b>24N</b> JPP 075 P01	<b>75</b>	<b>100</b>	2 x 25	11	32	<b>99</b>



70 KG

SERIE 14

- Durchmesser 75 mm
- Gehäuse aus Polyamid
- Thermoplastisches Gummirad

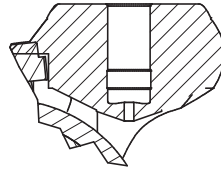

**GEHÄUSE**

- Polyamid
- Sackloch
- Radachse verschraubt

**RAD JPO**

- Radkörper aus Polypropylen
- Lauffläche aus thermoplastischem Gummi
- Farbe grau, spurlos
- Gleitlager



**KUNSTSTOFF-LENKROLLE MIT BUNDSTIFT-ANSCHRAUBPLATTE**

BESTELLCODE	mm	kg	mm	mm	mm	mm	mm	mm
14L JPO 075 B02-60x60	75	70	25	60 x 60	48 / 38 x 48 / 38	6,3	32	110



**KUNSTSTOFF-LENKROLLE MIT BUNDSTIFT-ANSCHRAUBPLATTE UND RADFESTSTELLER**

BESTELLCODE	mm	kg	mm	mm	mm	mm	mm	mm
14R JPO 075 B02-60x60	75	70	25	60 x 60	48 / 38 x 48 / 38	6,3	32	110



**KUNSTSTOFF-LENKROLLE MIT GEWINDESTIFT M 10 X 20**

BESTELLCODE	mm	kg	mm	mm	mm	mm
14L JPO 075 B09-M10x20	75	70	25	10	32	105



**KUNSTSTOFF-LENKROLLE MIT GEWINDESTIFT M 10 X 20 UND RADFESTSTELLER**

BESTELLCODE	mm	kg	mm	mm	mm	mm
14R JPO 075 B09-M10x20	75	70	25	10	32	105

**VARIANTEN:** Auch mit Rad GYO (elektrisch leitfähig, spurlos) lieferbar.



## GEHÄUSE

- Polyamid
- Sackloch
- Radachse verschraubt

## RAD JPP

- Radkörper aus Polypropylen
- Lauffläche aus thermoplastischem Gummi
- Farbe grau, spurlos
- Fadenschutz
- Präzisionskugellager

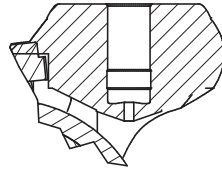

**70 KG**

- Durchmesser 75 mm
- Gehäuse aus Polyamid
- Thermoplastisches Gummirad

**APPARATE  
ROLLEN**

SERIE **14**



### KUNSTSTOFF-LENKROLLE MIT BUNDSTIFT-ANSCHRAUBPLATTE

BESTELLCODE	mm	kg	mm	mm	mm	mm	mm	mm
<b>14L</b> JPP 075 B02-60x60	<b>75</b>	<b>70</b>	25	60 x 60	48 / 38 x 48 / 38	6,3	32	<b>110</b>



### KUNSTSTOFF-LENKROLLE MIT BUNDSTIFT-ANSCHRAUBPLATTE UND RADFESTSTELLER

BESTELLCODE	mm	kg	mm	mm	mm	mm	mm	mm
<b>14R</b> JPP 075 B02-60x60	<b>75</b>	<b>70</b>	25	60 x 60	48 / 38 x 48 / 38	6,3	32	<b>110</b>



### KUNSTSTOFF-LENKROLLE MIT GEWINDESTIFT M 10 X 20

BESTELLCODE	mm	kg	mm	mm	mm	mm
<b>14L</b> JPP 075 B09-M10x20	<b>75</b>	<b>70</b>	25	10	32	<b>105</b>



### KUNSTSTOFF-LENKROLLE MIT GEWINDESTIFT M 10 X 20 UND RADFESTSTELLER

BESTELLCODE	mm	kg	mm	mm	mm	mm
<b>14R</b> JPP 075 B09-M10x20	<b>75</b>	<b>70</b>	25	10	32	<b>105</b>

**VARIANTEN:** Auch mit Rad GYP (elektrisch leitfähig, spurlos) lieferbar.



100 KG

- Durchmesser 75 - 125 mm
- Gehäuse aus Polyamid
- Thermoplastisches Gummirad

SERIE **05**

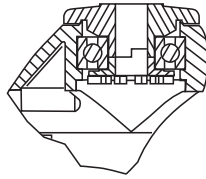

**GEHÄUSE**

- Glasfaserverstärktes Polyamid
- Präzisionskugellager als Kopflager
- Radachse verschraubt

**RAD JPO**

- Radkörper aus Polypropylen
- Lauffläche aus thermoplastischem Gummi
- Farbe grau, spurlos
- Gleitlager



**KUNSTSTOFF-LENKROLLE MIT ANSCHRAUBPLATTE**

BESTELLCODE	mm	kg	mm	mm	mm	mm	mm	mm
<b>05L</b> JPO <b>075</b> P04	75	100	30	77 x 67	61,5 / 56,0 x 51,5 / 46,5	8,5	41	<b>114</b>
<b>05L</b> JPO <b>100</b> P04	100	100	32	77 x 67	61,5 / 56,0 x 51,5 / 46,5	8,5	43	<b>140</b>
<b>05L</b> JPO <b>100</b> P05	100	100	32	95 x 70	75,0 x 50,0	11,0	43	<b>140</b>
<b>05L</b> JPO <b>125</b> P04	125	100	32	77 x 67	61,5 / 56,0 x 51,5 / 46,5	8,5	46	<b>169</b>
<b>05L</b> JPO <b>125</b> P05	125	100	32	95 x 70	75,0 x 50,0	11,0	46	<b>169</b>



**KUNSTSTOFF-LENKROLLE MIT ANSCHRAUBPLATTE UND TOTALFESTSTELLER**

BESTELLCODE	mm	kg	mm	mm	mm	mm	mm	mm
<b>05N</b> JPO <b>075</b> P04	75	100	30	77 x 67	61,5 / 56,0 x 51,5 / 46,5	8,5	41	<b>114</b>
<b>05N</b> JPO <b>100</b> P04	100	100	32	77 x 67	61,5 / 56,0 x 51,5 / 46,5	8,5	43	<b>140</b>
<b>05N</b> JPO <b>100</b> P05	100	100	32	95 x 70	75,0 x 50,0	11,0	43	<b>140</b>
<b>05N</b> JPO <b>125</b> P04	125	100	32	77 x 67	61,5 / 56,0 x 51,5 / 46,5	8,5	46	<b>169</b>
<b>05N</b> JPO <b>125</b> P05	125	100	32	95 x 70	75,0 x 50,0	11,0	46	<b>169</b>



**KUNSTSTOFF-LENKROLLE MIT RÜCKENLOCH**

BESTELLCODE	mm	kg	mm	mm	mm	mm
<b>05L</b> JPO <b>075</b> P01	75	100	30	10,2	41	<b>106</b>
<b>05L</b> JPO <b>100</b> P01	100	100	32	10,2	43	<b>135</b>
<b>05L</b> JPO <b>125</b> P01	125	100	32	10,2	46	<b>161</b>



**KUNSTSTOFF-LENKROLLE MIT RÜCKENLOCH UND TOTALFESTSTELLER**

BESTELLCODE	mm	kg	mm	mm	mm	mm
<b>05N</b> JPO <b>075</b> P01	75	100	30	10,2	41	<b>106</b>
<b>05N</b> JPO <b>100</b> P01	100	100	32	10,2	43	<b>135</b>
<b>05N</b> JPO <b>125</b> P01	125	100	32	10,2	46	<b>161</b>



Version 75 mm nur mit dieser abgerundeten Tritthebelversion lieferbar.

**VARIANTEN:** Lieferbar mit Zapfen Z01, Expanderbefestigung Z06 (Rundrohr) und Z07 (Vierkantrohr) oder Schrauben S01 sowie in schwarz. Alle Größen auch elektrisch leitfähig lieferbar.



## GEHÄUSE

- Glasfaserverstärktes Polyamid
- Präzisionskugellager als Kopflager
- Radachse verschraubt

## RAD JPP

- Radkörper aus Polypropylen
- Lauffläche aus thermoplastischem Gummi
- Farbe grau, spurlos
- Fadenschutz
- Präzisionskugellager

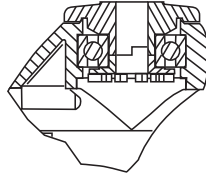

**100 KG**

- Durchmesser 75 - 125 mm
- Gehäuse aus Polyamid
- Thermoplastisches Gummirad

**APPARATE  
ROLLEN**

SERIE **05**



### KUNSTSTOFF-LENKROLLE MIT ANSCHRAUBPLATTE

BESTELLCODE	mm	kg	mm	mm	mm	mm	mm	mm
<b>05L</b> JPP 075 P04	75	100	30	77 x 67	61,5 / 56,0 x 51,5 / 46,5	8,5	41	<b>114</b>
<b>05L</b> JPP 100 P04	100	100	32	77 x 67	61,5 / 56,0 x 51,5 / 46,5	8,5	43	<b>140</b>
<b>05L</b> JPP 100 P05	100	100	32	95 x 70	75,0 x 50,0	11,0	43	<b>140</b>
<b>05L</b> JPP 125 P04	125	100	32	77 x 67	61,5 / 56,0 x 51,5 / 46,5	8,5	46	<b>169</b>
<b>05L</b> JPP 125 P05	125	100	32	95 x 70	75,0 x 50,0	11,0	46	<b>169</b>



### KUNSTSTOFF-LENKROLLE MIT ANSCHRAUBPLATTE UND TOTALFESTSTELLER

BESTELLCODE	mm	kg	mm	mm	mm	mm	mm	mm
<b>05N</b> JPP 075 P04	75	100	30	77 x 67	61,5 / 56,0 x 51,5 / 46,5	8,5	41	<b>114</b>
<b>05N</b> JPP 100 P04	100	100	32	77 x 67	61,5 / 56,0 x 51,5 / 46,5	8,5	43	<b>140</b>
<b>05N</b> JPP 100 P05	100	100	32	95 x 70	75,0 x 50,0	11,0	43	<b>140</b>
<b>05N</b> JPP 125 P04	125	100	32	77 x 67	61,5 / 56,0 x 51,5 / 46,5	8,5	46	<b>169</b>
<b>05N</b> JPP 125 P05	125	100	32	95 x 70	75,0 x 50,0	11,0	46	<b>169</b>



### KUNSTSTOFF-LENKROLLE MIT RÜCKENLOCH

BESTELLCODE	mm	kg	mm	mm	mm	mm	
<b>05L</b> JPP 075 P01	75	100	30		10,2	41	<b>106</b>
<b>05L</b> JPP 100 P01	100	100	32		10,2	43	<b>135</b>
<b>05L</b> JPP 125 P01	125	100	32		10,2	46	<b>161</b>



### KUNSTSTOFF-LENKROLLE MIT RÜCKENLOCH UND TOTALFESTSTELLER

BESTELLCODE	mm	kg	mm	mm	mm	mm	
<b>05N</b> JPP 075 P01	75	100	30		10,2	41	<b>106</b>
<b>05N</b> JPP 100 P01	100	100	32		10,2	43	<b>135</b>
<b>05N</b> JPP 125 P01	125	100	32		10,2	46	<b>161</b>



Version 75 mm nur mit dieser abgerundeten Tritthebelversion lieferbar.

**VARIANTEN:** Lieferbar mit Zapfen Z01, Expanderbefestigung Z06 (Rundrohr) und Z07 (Vierkantrohr) oder Schrauben S01 sowie in schwarz.  
 Alle Größen auch elektrisch leitfähig lieferbar.

